

# LES PORTES ALUMINIUM & MIXTE



# LÉGER, SOLIDE, RÉSISTANT, STABLE & DURABLE !

## Rassurant et tellement moderne !

Matériau résistant aux épreuves de la météo et garanti sans déformation, l'aluminium, symbole de modernité par excellence, vous permettra de donner un caractère unique à votre entrée. Recyclable à l'infini, il est un gage de respect de notre environnement.

Toutes les portes Atlantem aluminium ou mixte sont monobloc. Plus esthétiques, elles assurent un design épuré et moderne. Plus compactes et performantes en termes d'isolation thermique, les portes monobloc vous apportent sécurité et confort ! En version mixte, apportez une touche chaleureuse à votre intérieur. Outre ses qualités de robustesse, durabilité et de sécurité, l'aluminium est le matériau qui vous permet le plus grand choix en termes de couleurs et de finitions pour votre porte.



*Les portes qui nous ressemblent*

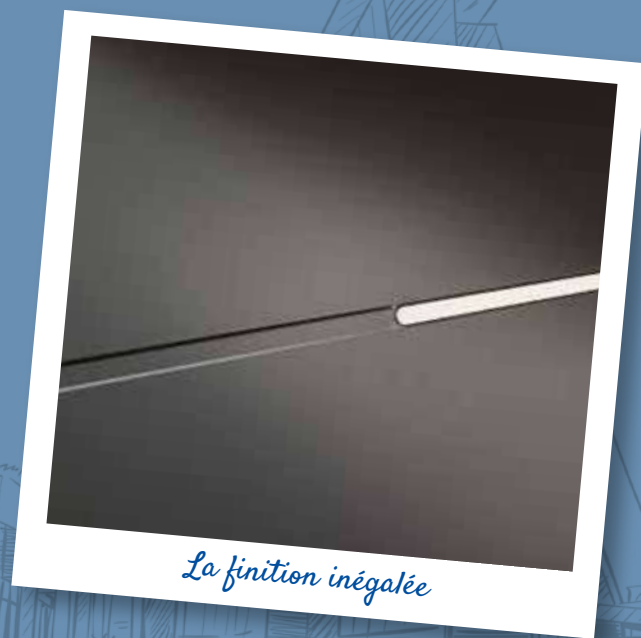

*La finition inégalée*

## PORTES MONOBLOC

Portes Tendance .....	44
Portes Tradition .....	76
Portes Alu First  .....	86

SÉLECTION  
**Atlante M**



**DUNN**  
RAL 5023, rainurage  
intérieur/extérieur,  
poignée rosace  
Nova inox.



Vue intérieure mixte  
**BLASCO**



**CROSS**  
RAL 9005, rainurage  
intérieur/extérieur,  
poignée rosace  
Nova inox.



Vue intérieure mixte  
**ARAMBOL**

SÉLECTION  
**Atlante M**



**GRANT**  
RAL 9005,  
rainurage intérieur/  
extérieur, poignée  
rosace Nova inox.



Vue intérieure mixte  
**BOVERO**



**MOORE**  
Bleu canon, décor lisse  
intérieur/extérieur,  
option barre de tirage.



Vue intérieure mixte  
**IPAS**

SÉLECTION  
Atlante M**REED**

RAL 7016,  
insert inox extérieur  
en applique, rainurage  
intérieur/extérieur,  
poignée rosace Nova  
inox.



Vue intérieure mixte  
**MESA**



Insert inox applique, rainurage du parement  
aluminium

**TYLER**

Bleu canon,  
rainurage intérieur/  
extérieur, poignée  
rosace Nova inox.



Vue intérieure mixte  
**PRADO**



Insert inox extérieur  
Mills

**MILLS**

RAL 7016,  
insert inox  
extérieur en  
applique,  
rainurage  
intérieur/  
extérieur,  
poignée  
rosace Nova  
inox.



Vue intérieure mixte  
**HERRERA**





PORTE **HOUSTON**  
RAL 7016

SÉLECTION  
Atlante M**HOUSTON**

RAL 7016, insert inox extérieur en applique, poignée rosace Nova inox, décor lisse intérieur en standard.



Vue intérieure mixte  
**ERAS**

**PARSON**

RAL 7022, insert inox intérieur/extérieur affleurant, rainurage intérieur/extérieur, poignée rosace Nova inox.



Vue intérieure mixte  
**ORTIS**

SÉLECTION  
Atlante M**NASH**

RAL 7016, insert inox extérieur en applique, poignée rosace Nova inox, décor lisse intérieur en standard.



Vue intérieure mixte  
**LANDRY**

SÉLECTION  
Atlante M**LEE**

RAL 7016, insert inox extérieur affleurant, rainurage intérieur/extérieur, poignée rosace Nova inox.



Vue intérieure mixte  
**FERRA**

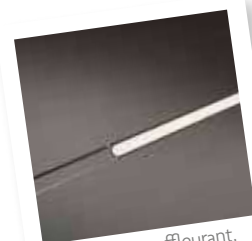

Insert inox affleurant,  
rainurage du parement  
aluminium





PORTE **GLOVER**  
RAL 9005



**GLOVER**  
RAL 7016, insert inox  
intérieur/extérieur  
affleurant, rainurage  
intérieur/extérieur, poignée  
rosace Nova inox.



Vue intérieure mixte  
**TRIANA**



**CRUZ**  
RAL 9005, insert inox  
extérieur en applique,  
rainurage intérieur/  
extérieur, poignée rosace  
Nova inox.

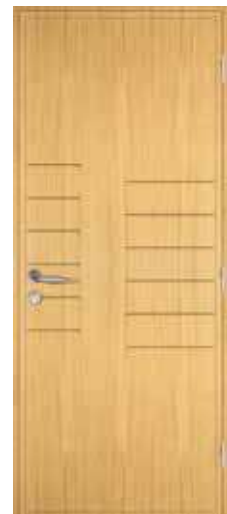

Vue intérieure mixte  
**ARANIAS**

SÉLECTION  
**AtlanteM****OPALE**

RAL 7016,  
insert céramique extérieur  
en applique, poignée rosace  
Nova inox, décor lisse  
intérieur en standard.



Vue intérieure mixte  
**LORENZO**

SÉLECTION  
**AtlanteM****QUARTZ**

RAL 7016,  
insert céramique extérieur  
en applique, poignée rosace  
Nova inox, décor lisse  
intérieur en standard.



Vue intérieure mixte  
**MARANA**

SÉLECTION  
**AtlanteM****PYRITE**

RAL 7016,  
insert céramique  
extérieur en applique,  
poignée rosace Nova  
inox, décor lisse  
intérieur en standard.



Vue intérieure mixte  
**LUCAS**



*Les portes qui nous ressemblent*





PORTE **TUCKER**  
Bleu canon



**BARTON**  
RAL 9007, poignée  
de tirage extérieure  
intégrée laquée à la  
couleur de la porte.



Vue intérieure mixte  
**PARDONO**



Poignée de tirage incrustée en inox



**TUCKER**  
RAL 7022, rainurage  
intérieur/extérieur,  
poignée de tirage  
incrustée en inox.



Vue intérieure mixte  
**ROSARIO**

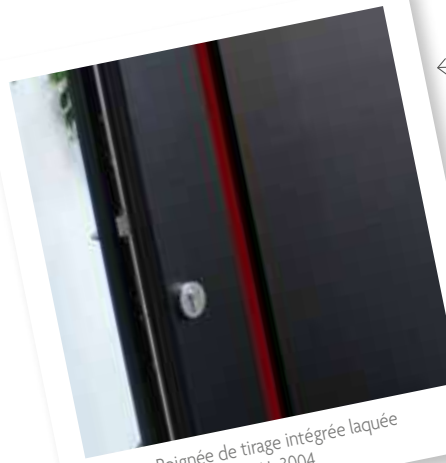

Poignée de tirage intégrée laquée  
RAL 3004

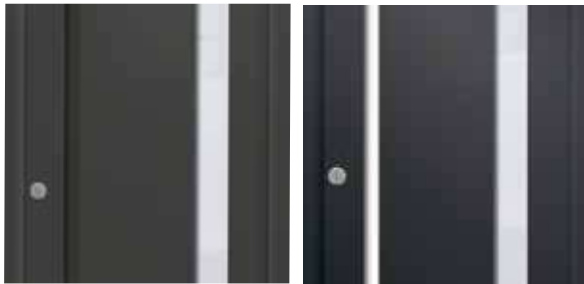

Poignée intégrée à  
la couleur de la porte

Poignée intégrée RAL 9016



### FLETCHER

Noir 2100 sablé,  
poignée de tirage  
extérieure intégrée  
laquée RAL 3004,  
vitrage dépoli 2 faces  
inclus.



Vue intérieure mixte  
**FELIPE**

SÉLECTION  
AtlanteM



Barre de tirage galbée



### WATSON

RAL 7016, barre de tirage  
extérieure en inox.



Vue intérieure mixte  
**PLAZA**



PORTE **DOUGLAS**  
RAL 7016



Poignée de tirage incrustée en inox



**DOUGLAS**  
RAL 8019,  
rainurage intérieur/  
extérieur, poignée de  
tirage incrustée en  
inox, vitrage dépoli  
2 faces inclus.



Vue intérieure mixte  
**RIBÉRA**



SÉLECTION  
Atlante M**OLSON**

RAL 7012, insert inox extérieur en applique, rainurage intérieur/extérieur, poignée rosace Nova inox, vitrage dépoli.



Vue intérieure mixte  
**MORENOS**



PORTE **FOSTER**  
RAL 7016

SÉLECTION  
Atlante M**FOSTER**

RAL 7039, insert inox extérieur en applique, rainurage intérieur/extérieur, poignée rosace Nova inox, vitrage dépoli.



Vue intérieure mixte  
**SALDANA**





PORTE **AUSTIN**



Grille motif Papyrus



Grille motif Jungle

**AUSTIN**

Grille motif Jungle ou Papyrus, poignée rosace Fold inox, vitrage dépoli. Grille motif Papyrus RAL 7016 texturé.

Vue intérieure alu  
**AUSTIN**Vue intérieure mixte  
**LEONARDO****DESIGN INÉDIT**signé  
**Atlante M****Personnalisez la couleur\* de la grille à vos envies**Grille motif Jungle  
RAL 3004 texturéGrille motif Jungle  
RAL 7016 texturéGrille motif Jungle  
RAL 9005 texturéGrille motif Jungle  
Noir 2100 sabléGrille motif Jungle  
Gris 2900 sabléGrille motif Jungle  
Gris clair SGP  
texturéGrille motif Jungle  
Gris métallique SMB  
texturéGrille motif Papyrus  
RAL 9006 texturé

\* 8 coloris disponibles





PORTE **TODD**  
RAL 7016

SÉLECTION  
Atlante M

**TODD**  
RAL 7016,  
rainurage intérieur/  
extérieur, poignée  
rosace Nova inox,  
vitrage dépoli.



Vue intérieure mixte  
**SELVA**

SÉLECTION  
Atlante M

**OLIVER**  
Bleu canon,  
poignée rosace  
Nova inox,  
vitrage dépoli.



Vue intérieure mixte  
**LAURIA**

SÉLECTION  
Atlante M

**TURNER**  
RAL 5023, insert  
inox extérieur en  
applique, rainurage  
intérieur/extérieur,  
poignée rosace  
Nova inox,  
vitrage dépoli.



Vue intérieure mixte  
**PORRA**

SÉLECTION  
Atlante M

**PHILLIPS**  
RAL 7016, rainurage  
int./ext., option barre  
de tirage, vitrage  
dépoli 2 faces inclus.



Vue intérieure mixte  
**SUAREZ**





PORTE **GROFF**  
Noir 2100 sablé



Insert inox extérieur en applique,  
rainurage, vitrage dépoli 2 faces

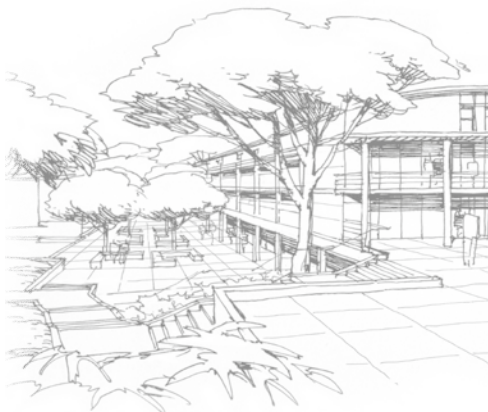

**GROFF**  
Noir 2100 sablé, insert  
inox extérieur en  
applique, rainurage  
intérieur/extérieur,  
poignée rosace Nova  
inox, vitrage dépoli  
2 faces inclus.



Vue intérieure mixte  
**MARQUEZ**





PORTE **FLORES**  
RAL 7016

SAUF MIXTE



**FLORES**  
RAL 7035, rainurage  
intérieur/extérieur,  
poignée rosace Nova  
inox, vitrage dépoli  
2 faces inclus.



Vue intérieure mixte  
**BLAVIS**

SÉLECTION  
**Atlante M**



**HOGAN**  
RAL 7016, poignée  
rosace Nova inox,  
vitrage dépoli.



Vue intérieure mixte  
**DUQUE**

SÉLECTION  
**Atlante M**



**ROY**  
RAL 3004, insert inox  
extérieur en applique,  
poignée rosace Nova  
inox, vitrage dépoli.



Vue intérieure mixte  
**NAVARO**



PORTE **PORTER**  
RAL 7016

**NOUVEAU**

**PORTER**

Gris 2900 sablé,  
insert inox intérieur/  
extérieur en applique  
en standard, poignée  
rosace Nova inox,  
vitrage dépoli  
2 faces inclus.



Vue intérieure mixte  
**SANCHO**





PORTE **RAMSEY**  
RAL 7016



Sablage Kim



Sablage Soto

SÉLECTION  
**Atlante M**



**BECKER**  
RAL 7012, rainurage intérieur/extérieur, poignée rosace Nova inox, vitrage dépoli.

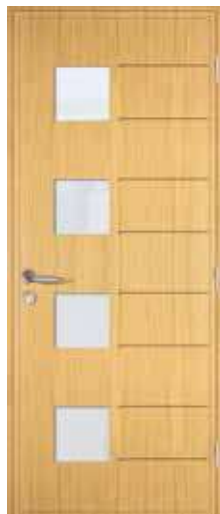

Vue intérieure mixte  
**ALEGRE**



**RAMSEY**  
RAL 7012, rainurage intérieur/extérieur, poignée rosace Nova inox, vitrage dépoli.



Vue intérieure mixte  
**SANGO**





PORTE **MAXWELL**  
RAL 7016



Vitrage dépoli, rainurage



**MAXWELL**  
RAL 7012, rainurage  
intérieur/extérieur,  
poignée rosace  
Nova inox,  
vitrage dépoli  
2 faces inclus.



Vue intérieure mixte  
**QUINTANA**

**POWELL**  
RAL 3004, insert inox  
extérieur en applique,  
poignée rosace Nova inox,  
option vitrage Aria.



Vue intérieure mixte  
**ORTEGA**



Fusing Aria rouge



Fusing Aria noir



PORTE **HART**  
RAL 7037

SAUF MIXTE

**HART**

RAL 9005, rainurage intérieur/extérieur, poignée rosace Nova inox, vitrage dépoli.



Vue intérieure mixte  
**CLAVERO**

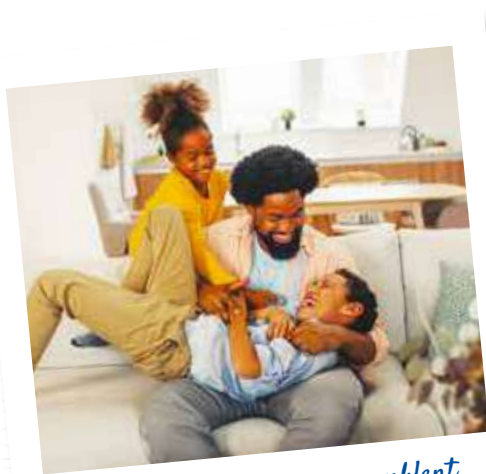

*Les portes qui nous ressemblent*

**NOUVEAU****STEWART**

RAL 7012, insert inox extérieur en applique, poignée rosace Nova inox, vitrage dépoli 2 faces inclus.



Vue intérieure mixte  
**OROSCO**



PORTE **OLIO** vue intérieure



Insert inox Scott

SÉLECTION  
**AtlanteM**

**SCOTT**  
RAL 7016, insert inox extérieur  
en applique, rainurage  
intérieur/extérieur, poignée  
rosace Nova inox,  
vitrage dépoli.



Vue intérieure Olio



Vue intérieure mixte  
**OLIO**







PORTE **HARVEY**  
RAL 7016

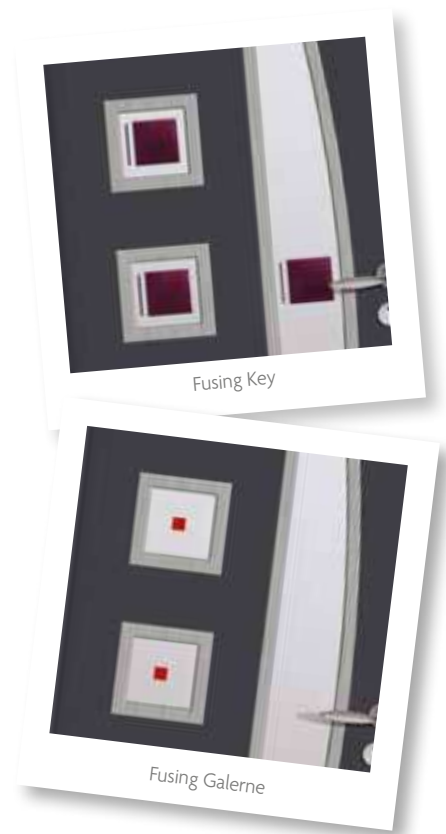

Fusing Key

Fusing Galerne



**DANIELS**

Noir 2100 sablé, insert inox intérieur/extérieur en applique en standard, rainurage intérieur/extérieur, poignée rosace Nova inox, vitrage dépoli 2 faces inclus.



Vue intérieure mixte  
**MOLI**



**HARVEY**

RAL 7016, insert inox extérieur en applique, poignée rosace Nova inox, vitrage dépoli.



Vue intérieure mixte  
**CRISTINA**



PORTE **HIGGINS**  
RAL 7037



Insert inox Higgins

**HIGGINS**

RAL 9005, insert inox intérieur/extérieur affleurant, rainurage intérieur/extérieur, poignée rosace Nova inox, vitrage dépoli 2 faces inclus.

SÉLECTION  
Atlante M**LUNA**

RAL 7016, rainurage intérieur/extérieur, poignée rosace Nova inox, vitrage dépoli.

Vue intérieure mixte  
**FUENTES****LEWIS**

RAL 7016, insert inox extérieur en applique, rainurage intérieur/extérieur, poignée rosace Nova inox, vitrage dépoli 2 faces inclus.

SÉLECTION  
Atlante MSÉLECTION  
Atlante M**OWENS**

RAL 9006 Galet, rainurage intérieur/extérieur, poignée rosace Nova inox, vitrage dépoli.

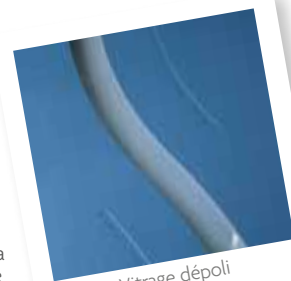

Vitrage dépoli

Vue intérieure mixte  
**LUCIO**Vue intérieure mixte  
**FONTANY**





PORTE **HARMON**  
RAL 7016



Rainurage et vitrage Harmon



**HARMON**  
RAL 7016, rainurage  
intérieur/extérieur,  
poignée rosace  
Nova inox, vitrage  
dépoli 2 faces  
inclus.



Vue intérieure mixte  
**AMIGO**

SÉLECTION  
**Atlante M**



**EVANS**

Bleu canon, insert pierre naturelle grise affleurant intérieur/extérieur, rainurage intérieur/extérieur, poignée rosace Nova inox, vitrage dépoli 2 faces inclus.



Vue intérieure mixte  
**MARTINEZ**

SÉLECTION  
**Atlante M**



**RICE**

RAL 7016, rainurage intérieur/extérieur, poignée rosace Nova inox, vitrage dépoli.



Vue intérieure mixte  
**MOLTO**



PORTE **COX**  
RAL 9005



**COX**

RAL 9005, insert inox extérieur en applique, rainurage intérieur/extérieur, poignée rosace Nova inox, vitrage dépoli.



Vue intérieure mixte  
**AMADOR**



PORTE **WALLACE**  
RAL 7016

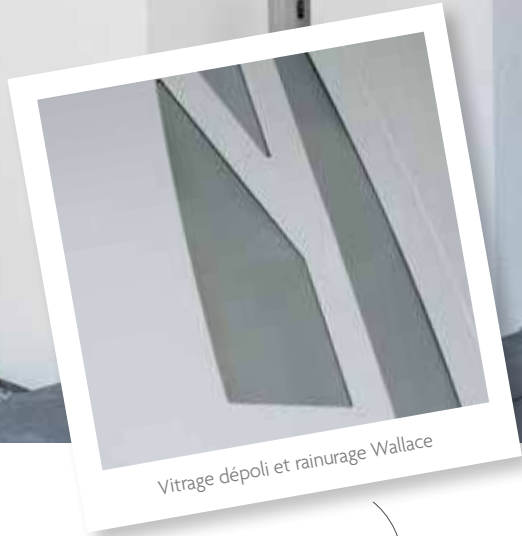

Vitrage dépoli et rainurage Wallace



**WALLACE**  
Gris 2900 sablé,  
rainurage intérieur/  
extérieur, poignée  
rosace Nova inox,  
vitrage dépoli 2 faces  
inclus.



Vue intérieure mixte  
**HERNANDEZ**



**NOUVEAU**

**SULLIVAN**  
Sablé Mars 2525,  
rainurage intérieur/  
extérieur, poignée  
rosace Nova inox,  
vitrage dépoli.



Vue intérieure mixte  
**REYES**





PORTE **CLARK**  
RAL 7016



**CLARK**  
RAL 7016, insert  
inox extérieur en  
applique, poignée  
rosace Nova inox  
vitrage dépoli.

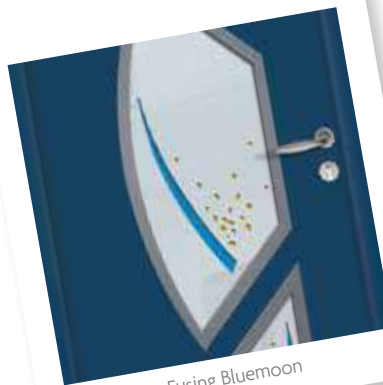

Fusing Bluemoon

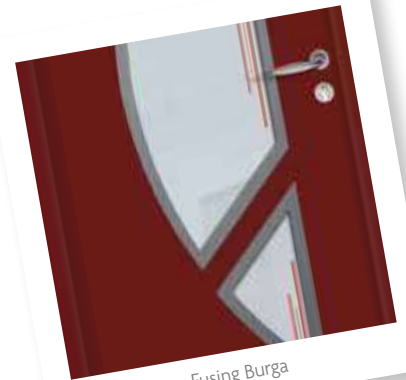

Fusing Burga



Vue intérieure mixte  
**ALVARO**





PORTE **JORDAN**  
RAL 7016



Rainurage et vitrage dépoli

**JORDAN**

Gris 2900 sablé, rainurage intérieur/extérieur, poignée rosace Nova inox, vitrage dépoli 2 faces inclus.

Vue intérieure mixte  
**GONZALEZ**SÉLECTION  
Atlante M**EDWARDS**

RAL 3004, insert inox extérieur en applique, option barre de tirage demi-lune, vitrage dépoli 2 faces inclus.

Vue intérieure mixte  
**VARGAS**SÉLECTION  
Atlante M**MITCHELL**

RAL 7035, rainurage intérieur/extérieur, option barre de tirage demi-lune, vitrage dépoli 2 faces inclus.

Vue intérieure mixte  
**AGUILA**





PORTE **ROSS**  
RAL 7022



**ROSS**

RAL 5003, rainurage intérieur/extérieur, poignée rosace Nova inox, vitrage dépoli.



Vue intérieure mixte  
**MUNOZ**

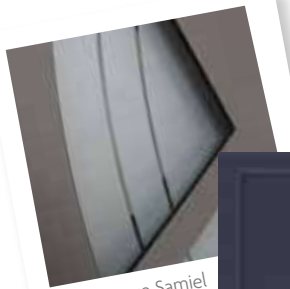

Vitrage Samiel



**WARD**

Bleu canon, poignée rosace Nova inox, vitrage dépoli 2 faces inclus.



Vue intérieure mixte  
**RAMIS**



**FERGUSON**

RAL 9005, insert inox intérieur/extérieur en applique, poignée rosace Nova inox, vitrage dépoli 2 faces inclus.



Vue intérieure mixte  
**MURILLO**

SÉLECTION  
Atlante M**PENY**

Gris métallisé SMB, rainurage intérieur/extérieur, poignée rosace Nova inox, vitrage dépoli 2 faces inclus.



Vue intérieure mixte  
**NACHER**

**NORTON**

Gris 2900 sablé, insert inox extérieur (uniquement) en applique, rainurage intérieur/extérieur, poignée rosace Nova inox, vitrage dépoli 2 faces inclus.



Vue intérieure mixte  
**ARRIO**

SÉLECTION  
Atlante M

Vitrage Solana en option

**GRAY**

RAL 9005, rainurage intérieur/extérieur, poignée rosace Nova inox, vitrage dépoli.

SAUF MIXTE



Vue intérieure mixte  
**CALDER**





PORTE **SMITH**  
RAL 7016



PORTE **SMITH**

**SMITH**  
RAL 7039,  
mouluration  
rappotée 2 faces,  
cimaise et jet d'eau  
extérieur, poignée  
plaque Nova inox,  
vitrage dépoli  
avec grille incorporée,  
option boîte aux  
lettres (disponible  
sur porte de  
950 mm de  
largeur mini.),  
option bâton de  
maréchal aspect  
inox brossé.

---

**EXEMPLES D'ÉLÉVATION MODÈLE SMITH**

---



780 x 2018 mm\*



950 x 2184 mm\*



970 x 2200 mm\*

\*Dimensions Hors Tout





PORTE **FLEMING**



Grille incorporée

**NOUVEAU**

**FLEMING**  
 Bleu canon, mouluration rapportée 2 faces, cimaise et jet d'eau extérieur, poignée plaque Nova inox, vitrage dépoli avec grille incorporée, option bâton de maréchal aspect inox brossé.



**EXEMPLES D'ÉLEVATION MODÈLE FLEMING**



780 x 2018 mm\*



950 x 2184 mm\*



970 x 2200 mm\*

\*Dimensions Hors Tout

**WILLIAMS**

RAL 7022, mouluration rapportée 2 faces, cimaise et jet d'eau extérieur, poignée plaque Nova inox, vitrage dépoli avec grille incorporée, option bâton de maréchal aspect inox brossé.

**EXEMPLES D'ÉLEVATION MODÈLE WILLIAMS**

780 x 2018 mm\*



950 x 2184 mm\*



970 x 2200 mm\*

\*Dimensions Hors Tout



Grille volutes



*Les portes qui nous ressemblent*

**JACKSON**

RAL 7037 mouluration rapportée 2 faces, cimaise et jet d'eau extérieur, poignée plaque Nova inox, vitrage delta clair, option bâton de maréchal aspect inox brossé (vitrage clair non réalisable).





DONNEZ DE L'AMPLEUR  
À VOTRE ENTRÉE  
**Optez pour un semi-fixe latéral**



PORTE **WILLIAMS** + SEMI-FIXE vitré avec grille  
RAL 7022



**SMITH**  
**+ SEMI-FIXE**  
(vitrée avec grille  
incorporée).  
RAL 7016,  
mouluration  
rapportée 2 faces,  
cimaise et jet d'eau  
extérieur, poignée  
plaque Nova inox,  
vitrage dépoli  
avec grille  
incorporée.



**ATKINS**  
**+ SEMI-FIXE**  
RAL 7016,  
mouluration  
rapportée  
2 faces,  
cimaise et jet  
d'eau extérieur,  
poignée  
plaque Nova  
inox.



**JACKSON**  
**+ SEMI-FIXE**  
**VITRE**  
RAL 7016,  
mouluration  
rapportée 2 faces,  
cimaise et jet  
d'eau extérieur,  
poignée plaque  
Nova inox, vitrage  
dépoli.



PORTE **PALMER**  
RAL 7016

**NOUVEAU**

**PALMER**  
RAL 7012  
mouluration  
rapportée 2 faces,  
poignée rosace  
Nova inox, vitrage  
delta clair.



**NOUVEAU**

**DÉCORS GRILLES IMPRESSION NUMÉRIQUE**



Vitrage Arès



Vitrage Éris



Vitrage Thémis



Vitrage Éole



Vitrage Déméter

SÉLECTION  
**AtlanteM**



**CURTIS**  
RAL 7016, mouluration  
intérieure/extérieure,  
poignée plaque Nova  
laiton, vitrage delta clair  
avec option petits bois  
incorporés laiton.



Vue intérieure mixte  
**ARBONA**



Vitrage plomb Opus



Vitrage plomb Opus



PORTE **CURTIS**  
RAL 7037



Vitrage Reyès

SAUF MIXTE

**NOUVEAU** DÉCORS GRILLES IMPRESSION NUMÉRIQUE



Vitrage Arès



Vitrage Éris



Vitrage Thémis



Vitrage Éole



Vitrage Déméter





**WHITE**  
RAL 8014, mouluration intérieure/extérieure, poignée plaque Nova laiton, option vitrage Chinock.



Vue intérieure mixte  
**ROMANO**

**NOUVEAU**  
**DÉCOR GRILLE IMPRESSION NUMÉRIQUE**



Vitrage Déméter



Vitrage Bevel naturel



Vitrage Opus

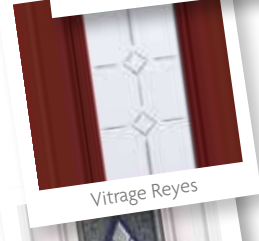

Vitrage Reyes



Chamsin (bleu, vert, rouge ou clair)



Vitrail Diamant



**BROWN**  
RAL 7016, mouluration intérieure/extérieure, poignée plaque Nova laiton, vitrage delta clair avec option petits bois incorporés laiton.



Vue intérieure mixte  
**ALTAR**



Vitrail Aigol



Vitrail Flower



**TERRY**

RAL 7012, mouluration intérieure/extérieure, poignée plaque Nova inox, option vitrage Sodalite.



Vue intérieure mixte  
**PINAZO**



**HILL**

RAL 6021, mouluration intérieure/extérieure, poignée plaque Nova inox, option vitrage Chamsin clair.



Vitrage Flower

Vue intérieure mixte  
**DIAZ**



**ALLEN**

RAL 1015, mouluration intérieure/extérieure, poignée plaque Nova inox, option vitrage Chamsin vert.



**HARRIS**

RAL 8014, mouluration intérieure/extérieure, poignée plaque Nova laiton, vitrage delta clair avec option petits bois incorporés laiton.



Vue intérieure mixte  
**CASSOLI**

**DAVIS**

RAL 1015, mouluration intérieure/extérieure, poignée plaque Nova laiton, vitrage delta clair avec option petits bois incorporés laiton.



Vue intérieure mixte  
**AROCA**

**ATKINS**

RAL 7016, mouluration rapportée 2 faces, cimaise et jet d'eau extérieur, poignée plaque Nova inox, option bâton de maréchal aspect inox brossé.

SÉLECTION  
**Atlante M**

**RAY**

RAL 7016, mouluration intérieure/extérieure, poignée plaque Nova inox.



Vue intérieure mixte  
**MATEO**





PORTE **COOPER**



**NOUVEAU**



**COOPER**  
Bleu canon,  
insert inox  
2 faces,  
poignée  
rosace Nova  
inox.



**WARREN**  
RAL 7016,  
rainurage  
intérieur/  
extérieur,  
poignée  
rosace  
Nova inox,  
vitrage  
dépoli.



**GORDON**  
RAL 7037,  
rainurage  
intérieur/  
extérieur,  
poignée  
rosace  
Nova inox.



**MACKAY**

Noir 2100 sablé,  
poignée rosace  
Nova inox,  
vitrage dépoli.



**WADE**

Gris 2900 sablé,  
rainurage intérieur/  
extérieur, poignée  
rosace Nova inox.



**THOMPSON**

RAL 5023,  
poignée rosace  
Nova inox, vitrage  
dépoli.

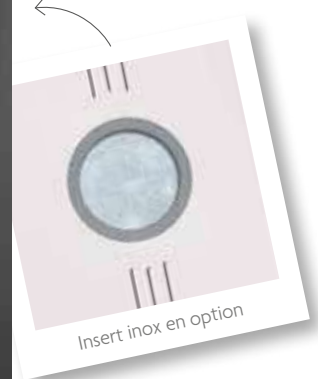

**MORRIS**

Noir 2100 sablé,  
rainurage intérieur/  
extérieur,  
poignée rosace  
Nova inox.



# ESTHÉTIQUE

Monocore, bicolore ou mixte, vous avez le choix

## EN VERSION MONOCOLORATION

un grand choix de couleurs  
(intérieur/extérieur identique).



## EN VERSION BICOLORATION

le choix de la couleur en extérieur,  
la sobriété et neutralité du blanc  
à l'intérieur de votre habitation.



## EN VERSION MIXTE

le design de l'aluminium à l'extérieur avec  
ses nombreuses couleurs au choix, la  
chaleur et l'esthétique du bois à l'intérieur.

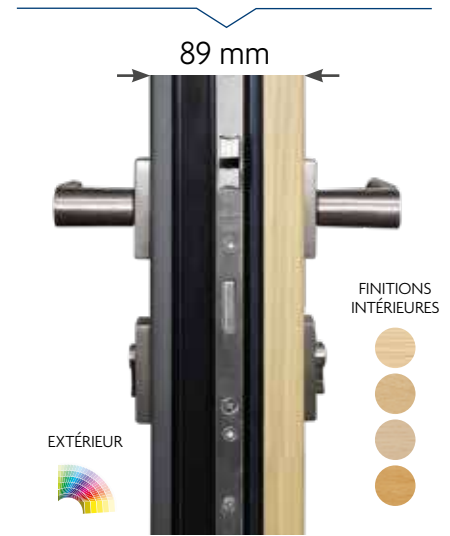

sauf Allen, Higgins, Williams, Smith et Jackson, Atkins et modèles First.

# TYPES D'OUVERTURES

Des formes et compositions personnalisées !

## 1 VANTAIL



## 2 VANTAUX À OUVERTURE TOTALE

Sauf portes First

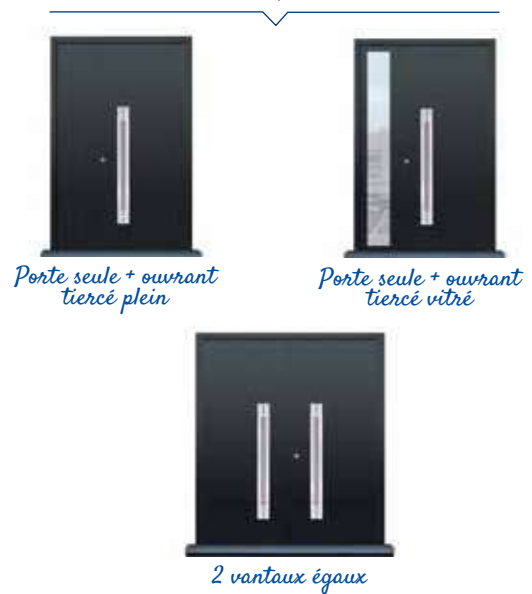



# COULEURS ALUMINIUM

Personnalisez votre porte

## LES COULEURS STANDARDS



## LES COULEURS EN OPTION

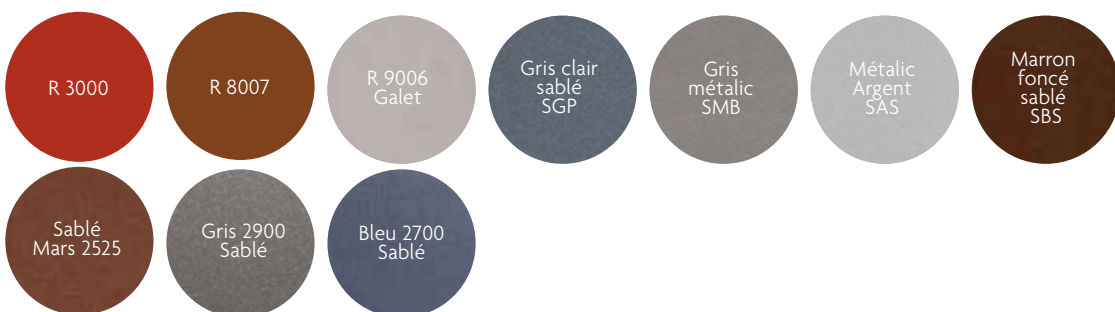

## PORTE MIXTE : 4 FINITIONS INTÉRIEURES BOIS



...ET PLUS DE 250  
COULEURS RAL  
SUR DEMANDE



# CONFORT

Une bonne isolation pour gagner en confort et en économie d'énergie !

La porte monobloc améliore l'isolation d'une porte en alu. La structure à rupture de ponts thermiques et la qualité des joints augmentent considérablement son étanchéité et ses performances thermiques.

Les Portes Atlantem vous garantissent un coefficient thermique performant :

jusqu'à : **Ud de 1,09 W/m<sup>2</sup>.K\***

Le coefficient Ud permet de mesurer l'isolation thermique apportée par la porte d'entrée. Plus ce coefficient est bas, plus votre porte est isolante.

**Le saviez-vous ?** Le remplacement d'une porte ayant un Ud de 1,6 par une porte avec un Ud de 1,1 W/(m<sup>2</sup>.K) permet de réduire de 30% les déperditions d'énergie.

\*pour un modèle plein en aluminium (détail pour chaque modèle page 156)



## Autre alternative ! PORTE ALU FIRST

**OUVRANT MONOBLOC** à rupture de pont thermique de 79 mm d'épaisseur

**2 TÔLES LAQUÉES** de 1,5 mm d'épaisseur

**SERRURE À RELEVAGE**

**FICHES AU RÉGLAGE TRIDIMENSIONNEL**



### INNOVANT !

#### Dormant hybride

Le bon matériau au bon endroit (le PVC pour son pouvoir isolant, l'aluminium pour sa résistance et son esthétique, le bois pour son aspect chaleureux)

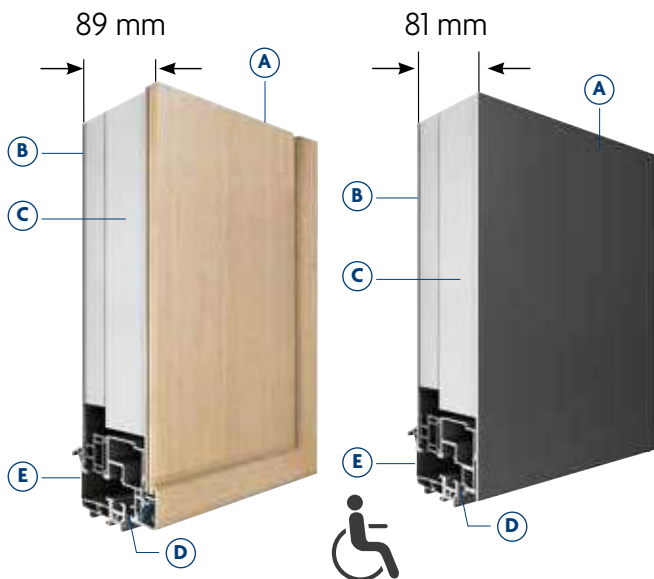

- A** **OUVRANT MONOBLOC** à rupture de pont thermique.
- B** **2 TÔLES LAQUÉES** de 2,5 mm d'épaisseur
- C** **66 MM DE MOUSSE** résistante à l'humidité et imputrescible
- D** **DOUBLE JOINT D'ÉTANCHÉITÉ**
- E** **SEUIL ALUMINIUM** de 20 mm à rupture de pont thermique conforme à la réglementation PMR (personne à mobilité réduite)

- **DORMANT** de 65 mm à rupture de pont thermique
- **TAPÉES DÉPORTÉES** permettant d'augmenter la dimension passage

**En option :** barre de tirage avec serrure manœuvre à clé  
**Mixte :** parement en contreplaqué en bois de 8 mm d'épaisseur (gage de qualité dans le temps).

VISITEZ EN VIDÉO NOS ATELIERS DE FABRICATION

De portes monobloc aluminium



# SÉCURITÉ : SÉRÉNITÉ !

Toutes les portes sont équipées d'une serrure à déclenchement automatique 5 points.  
Atlantem met à votre disposition des options pour encore plus de sécurité, disponibles en alu et en mixte.



*Serrure 5 points en standard !*



*Triple vitrage feuilleté contre l'effraction !*

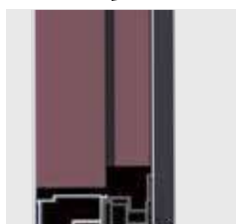

*Écran acoustique*

**Écran acoustique** de 5 mm d'épaisseur en option pour renforcer les performances phoniques : **jusqu'à 33 dB** pour un modèle plein (Sauf porte d'entrée cintrée).



## *Pratique !*

**Paumelles au réglage tridimensionnel** sans dégonder l'ouvrant ! Autolubrifiantes et gainées en polyacétal, sans effet trace noire sur les murs ! **Indégonnable** de l'extérieur !

## OPTIONS DE SÉCURITÉ RENFORCÉE

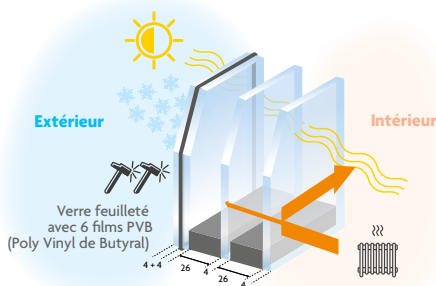

### TRIPLE VITRAGE SP510

Verre de sécurité qui possède la capacité de résister et de retarder une tentative d'effraction grâce à sa composition.



**SERRURE À GOUJONS** : 2 goujons, 3 pènes 1/2 tour et 1 pêne dormant conforme classe sécurité RC2.

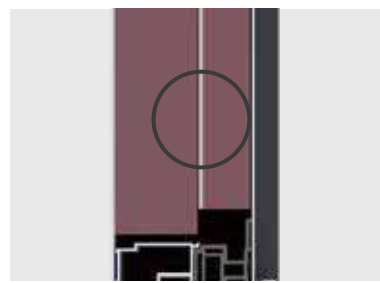

**TÔLE ALUMINIUM DE 1,8 MM** d'épaisseur pour améliorer la sécurité (disponible sur tous les modèles y compris les modèles vitrés). *Sauf First.*